

# ARTESYN

## ADQ600B-48S12B

### 600 Watts Quarter Brick Converter



## PRODUCT DESCRIPTION

Advanced Energy's Artesyn ADQ600B-48S12B is a single output DC/DC converter with standard quarter brick form factor and pin configuration. It delivers up to 50A output current with 12V output. Ultra-high 95.5% efficiency and excellent thermal performance makes it an ideal choice for use in computing and telecommunication applications and can operate over an ambient temperature range of  $-40^{\circ}\text{C} \sim +85^{\circ}\text{C}$ .

## SPECIAL FEATURES

- Delivering up to 50A output
- Ultra-high efficiency 95.5% typ. at half load
- Wide input range: 36 to 75Vdc
- Startup Pre-bias:  $0\%V_{out} \sim 95\%V_{out}$
- Excellent thermal performance
- No minimum load requirement
- RoHS3.0 (2011/65/EU)
- Remote control function
- Remote output sense
- Trim
- Input under voltage lockout
- Output over current protection
- Output over voltage protection
- Over temperature protection
- DOSA footprint compliant
- PMBus Rev. 1.2 compliant
- Pin length option: 3.8mm

## SAFETY

- IEC/EN/UL/CSA 62368
- UL/TUV
- UL94,V-0
- CE and UKCA Mark

## TYPICAL APPLICATIONS

- Telecom
- Datacom

## AT A GLANCE

### Total Power

600 Watts

### Input Voltage

36-75 Vdc

### # of Outputs

Single



## Model Numbers

Standard	Output Voltage	Structure	Remote ON/OFF logic	ROHS	PMBus Interface Option
ADQ600B-48S12B-6LK	12Vdc	Baseplate	Negative	RoHS3.0 (2011/65/EU)	No
ADQ600B-48S12B-6LI	12Vdc	Baseplate	Negative	RoHS3.0 (2011/65/EU)	Yes

## Order Information

ADQ600B	-	48	S	12	B	-	6	L	K
①		②	③	④	⑤		⑥	⑦	⑧

①	Model series	ADQ: high efficiency quarter brick series, 600: output power 600W
②	Input voltage	48: 36V ~ 75V input range, rated input voltage 48V
③	Output number	S: single output
④	Rated output voltage	12: 12V output
⑤	Baseplate	B: with baseplate; default: open frame
⑥	Pin length	Omit for 5.8mm±0.25mm 4: 4.8mm±0.25mm 6: 3.80mm±0.25mm 8: 2.80mm±0.25mm
⑦	RoHS status	L: RoHS3.0 (2011/65/EU)
⑧	PMBus Interface Option	K: No I: Yes

## Options

Pin length optional

PMBus optional

## Electrical Specifications

### Absolute Maximum Ratings

Stress in excess of those listed in the “Absolute Maximum Ratings” may cause permanent damage to the power supply. These are stress ratings only and functional operation of the unit is not implied at these or any other conditions above those given in the operational sections of this TRN. Exposure to any absolute maximum rated condition for extended periods may adversely affect the power supply’s reliability.

Table 1. Absolute Maximum Ratings						
Parameter	Model	Symbol	Min	Typ	Max	Unit
Input Voltage	Operating -Continuous	All	-	-	80	Vdc
	Non-operating -100mS	All	-	-	100	Vdc
Maximum Output Power	All	$P_{O,max}$	-	-	600	W
Ambient Operating Temperature	All	$T_A$	-40	-	+85	°C
Storage Temperature	All	$T_{STG}$	-55	-	+125	°C
Voltage at remote ON/OFF pin	All		-0.3	-	18	Vdc
Humidity (non-condensing)	Operating	All	-	-	95	%
	Non-operating	All	-	-	95	%

## Electrical Specifications

### Input Specifications

Table 2. Input Specifications						
Parameter	Conditions <sup>1</sup>	Symbol	Min	Typ	Max	Unit
Operating Input Voltage, DC	All	$V_{IN,DC}$	36	48	75	Vdc
Turn-on Voltage Threshold	$I_O = I_{O,max}$	$V_{IN,ON}$	-	35	-	Vdc
Turn-off Voltage Threshold	$I_O = I_{O,max}$	$V_{IN,OFF}$	-	33	-	Vdc
Lockout Voltage Hysteresis	$I_O = I_{O,max}$		-	2	-	Vdc
Maximum Input Current ( $I_O = I_{O,max}$ )	$V_{IN,DC} = 36Vdc$ $I_O = I_{O,max}$	$I_{IN,max}$	-	-	20	A
No load input current	$V_{IN,DC} = 48Vdc$		-	0.10	-	A
Standby Input current	Remote OFF		-	0.01	0.1	A
Recommended Input Fuse	Fast blow external fuse recommended		-	-	30	A
Input Filter Component Values (C\L)	Internal values		-	9.4\0.33	-	$\mu F\backslash\mu H$
Recommended External Input Capacitance	Low ESR capacitor recommended	$C_{IN}$	220	-	-	$\mu F$
Input Reflected Ripple Current	Through 12uH inductor		-	70	-	mA
Operating Efficiency <sup>2</sup>	$T_A = 25\text{ }^\circ C$ $I_O = I_{O,max}$ $I_O = 50\%I_{O,max}$	$\eta$	-	94.5	-	%
			-	95.5	-	%

Note 1 -  $T_A = 25\text{ }^\circ C$ , airflow rate = 400 LFM,  $V_{in} = 48Vdc$ , nominal  $V_{out}$  unless otherwise noted.

Note 2 - Refer to figure 9

## Electrical Specifications

### Output Specifications

Table 3. Output Specifications							
Parameter	Conditions <sup>1</sup>	Symbol	Min	Typ	Max	Unit	
Factory Set Voltage	$I_O=I_{O,max}$	$V_O$	11.88	12	12.12	Vdc	
Output Voltage Line Regulation	All	$V_O$	-	20	60	mV	
Output Voltage Load Regulation	All	$V_O$	-	20	60	mV	
Output Voltage Temperature Regulation	All	$V_O$	-	0.002	0.02	%/°C	
Output Voltage Trim Range	All	$V_O$	-33		10	%	
Output Ripple, pk-pk	0 to 20MHz bandwidth	$V_O$	-	100	400 <sup>2</sup>	$mV_{PK-PK}$	
Output Current	All	$I_O$	0	-	50	A	
Output DC current-limit inception <sup>3</sup>	All	$I_O$	55	-	70	A	
$V_O$ Load Capacitance <sup>4</sup>	All	$C_O$	2200		5200	$\mu F$	
$V_O$ Dynamic Response Peak Deviation Settling Time	50% ~ 75% ~ 50% $I_{O,max}$ 0.1A/ $\mu s$	$\pm V_O$ $T_s$	- -	300 300	- -	mV $\mu s$	
	50% ~ 75% ~ 50% $I_{O,max}$ 1A/ $\mu s$	$\pm V_O$ $T_s$	- -	300 300	- -	mV $\mu s$	
Turn-on transient	Rise time	$I_O=I_{O,max}$	$T_{rise}$	-	48	100	mS
	Turn-on delay time	$I_O=I_{O,max}$	$T_{turn-on}$	-	65	100	mS
	Output voltage overshoot	$I_O = 0$	% $V_O$	-	0	-	%
Isolation Voltage Input to output	1mA for 60s Slew rate of 500V/1s		2250	-	-	Vdc	
Switching frequency	All	$f_{sw}$	-	175	-	KHz	
Remote ON/OFF control (negative logic)	Off-state voltage	All		3.5	-	18	Vdc
	On-state voltage	All		-0.3	-	1.2	Vdc

Note 1 -  $T_a = 25^\circ C$ , airflow rate = 400 LFM,  $V_{in} = 48Vdc$ , nominal  $V_{out}$  unless otherwise noted.

Note 2 - 400mV is for whole range including input voltage, load and temperature.

Note 3 - Hiccup: auto-restart when over-current condition is removed.

Note 4 - the minimal capacitance is 2200 $\mu F$  Al electrolytic and the maximal capacitance is 2200 $\mu F$  Al electrolytic plus 3000 $\mu F$  MLCC or similar type.

## Electrical Specifications

### Output Specifications

Table 3. Output Specifications Con't							
Parameter		Conditions	Symbol	Min	Typ	Max	Unit
Remote ON/OFF control (Negative logic)	Off-state voltage	All		3.5	-	18	Vdc
	On-state voltage	All		-0.3	-	1.2	Vdc
Output over-voltage protection <sup>5</sup>		All	V <sub>O</sub>	13.8	-	16	Vdc
Pre-bias		All		0	-	95	%
Output over-temperature protection <sup>6</sup>		All		-	100	-	°C
Over-temperature hysteresis		All		5	-	-	°C
+ Sense		All	V <sub>O</sub>	-	-	+0.5	Vdc
- Sense		All	V <sub>O</sub>	-	-	-0.5	Vdc
MTBF		Telcordia SR-332-2006; 80% load, 300LFM, 40 °C T <sub>A</sub> SR332 Method 1 Case1		-	1.5	-	10 <sup>6</sup> h

Note 5 - Hiccup: auto-restart when over-voltage condition is removed.

Note 6 - Auto recovery.

# Electrical Specifications

## ADQ600B-48S12B Performance Curves

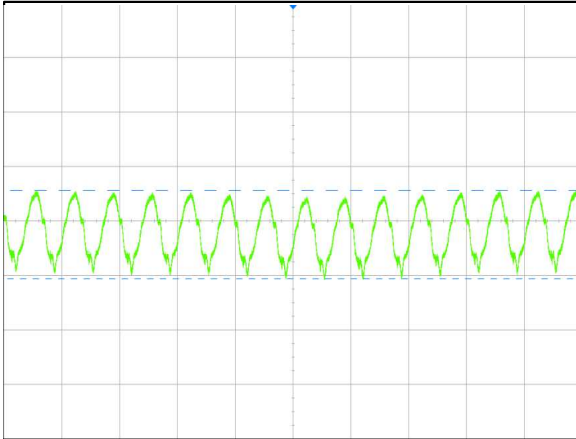

Figure 1: ADQ600B-48S12B Input Reflected Ripple Current  
 Vin = 48Vdc Load: Io = 50A  
 Ch 1: Iin (5uS/div, 50mA/div)

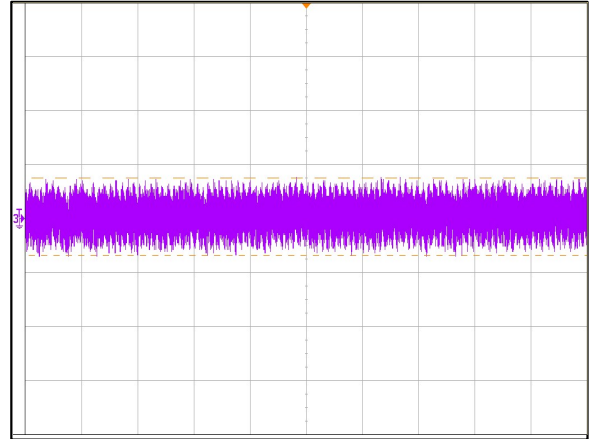

Figure 2: ADQ600B-48S12B Ripple and Noise Measurement  
 Vin = 48Vdc Load: Io = 50A  
 Ch 3: Vo (1ms/div, 50mV/div)

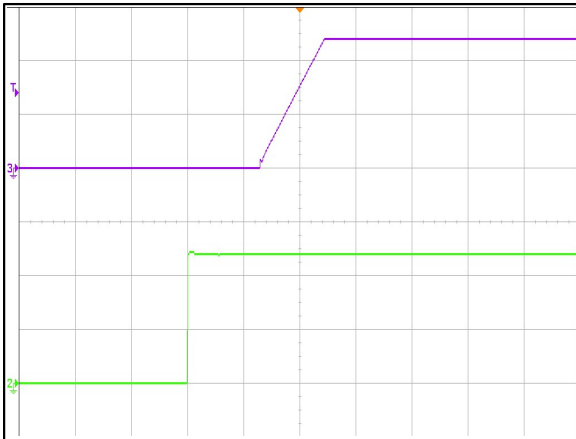

Figure 3: ADQ600B-48S12B Output Voltage Startup Characteristic  
 Vin = 48Vdc Load: Io = 50A (50mS/div)  
 Ch 2: Vi (20V/div) Ch 3: Vo (5V/div)

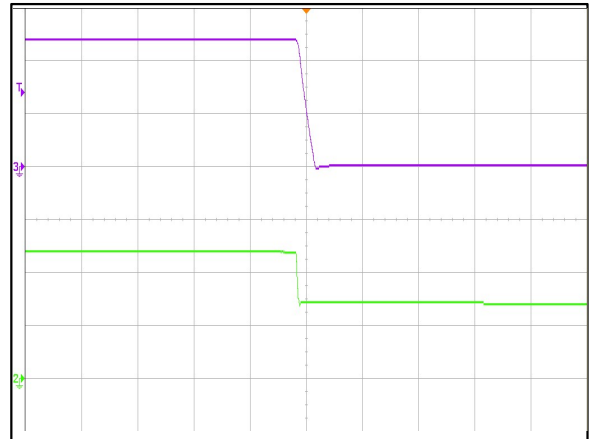

Figure 4: ADQ600B-48S12B Turn Off Characteristic (5mS/div)  
 Vin = 48Vdc Load: Io = 50A  
 Ch 2: Vi (20V/div) Ch 3: Vo (5V/div)

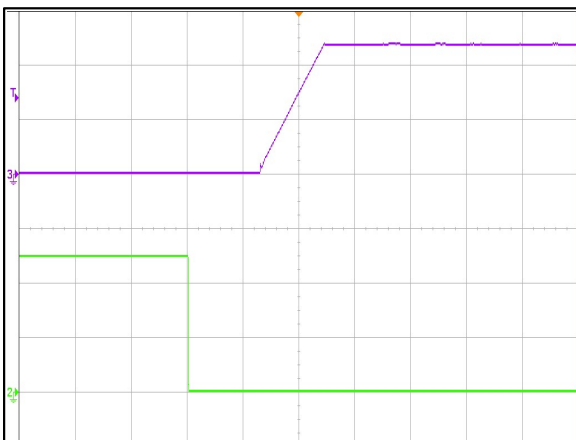

Figure 5: ADQ600B-48S12B Remote ON Waveform (50mS/div)  
 Vin = 48Vdc Load: Io = 50A  
 Ch 2: Remote ON (2V/div) Ch 3: Vo (5V/div)

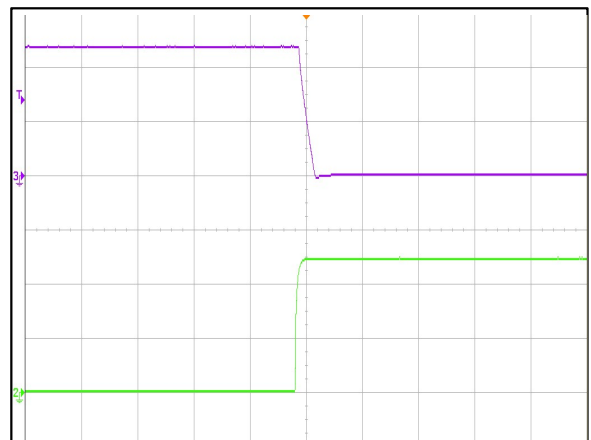

Figure 6: ADQ600B-48S12B Remote OFF Waveform (5mS/div)  
 Vin = 48Vdc Load: Io = 50A  
 Ch 2: Remote OFF (2V/div) CH3: Vo (5V/div)

# Electrical Specifications

## ADQ600B-48S12B Performance Curves

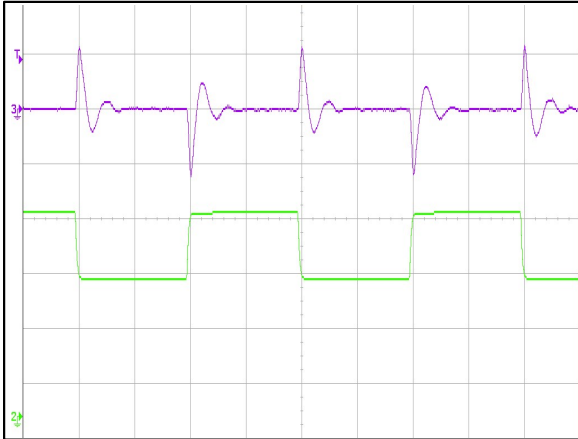

Figure 7: ADQ600B-48S12B Transient Response (2mS/div)  
50%-75%-50% load change, 0.1A/uS slew rate, Vin = 48Vdc  
Ch 2: Io (10A/div) Ch 4: Vo (200mV/div)

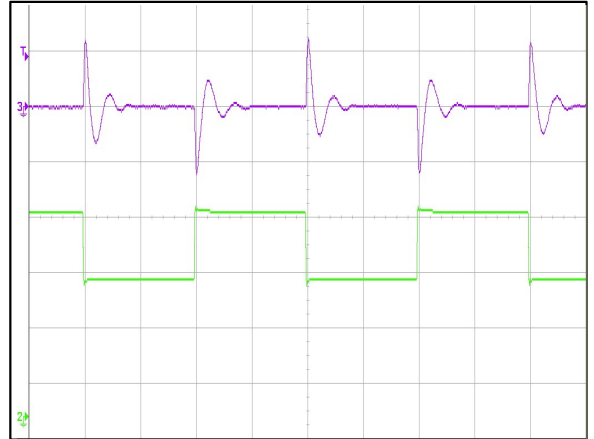

Figure 8: ADQ600B-48S12B Transient Response (2mS/div)  
50%-75%-50% load change, 1A/uS slew rate, Vin = 48Vdc  
Ch 2: Io (10A/div) Ch 4: Vo (200mV/div)

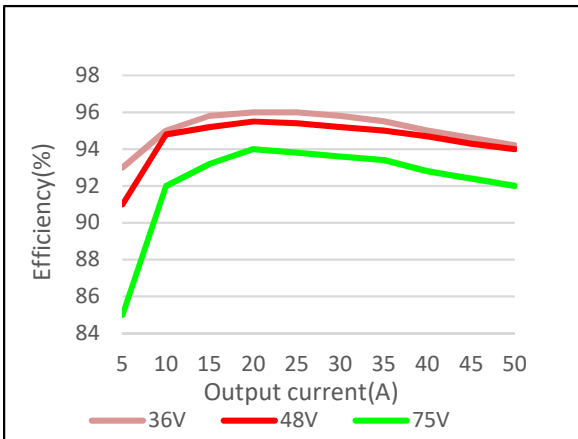

Figure 9: ADQ600B-48S12B Efficiency curve@25 degC  
Loading: Io=5~50A

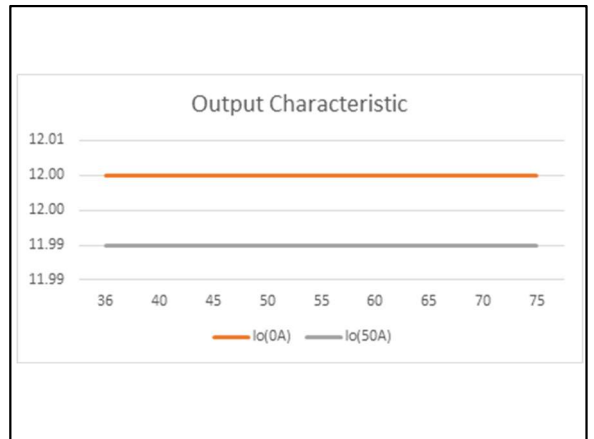

Figure 10: ADQ600B-48S12B Output Characteristic  
Loading: Io=0~50A

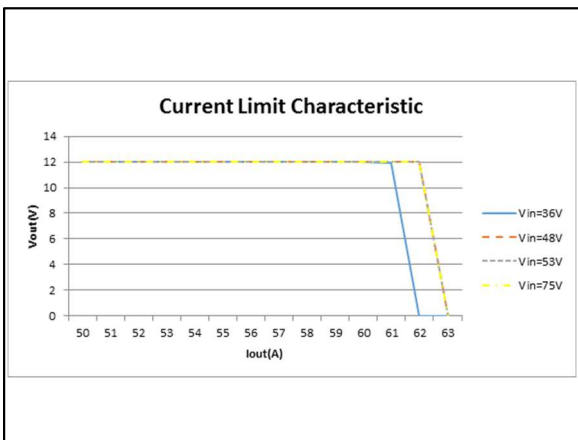
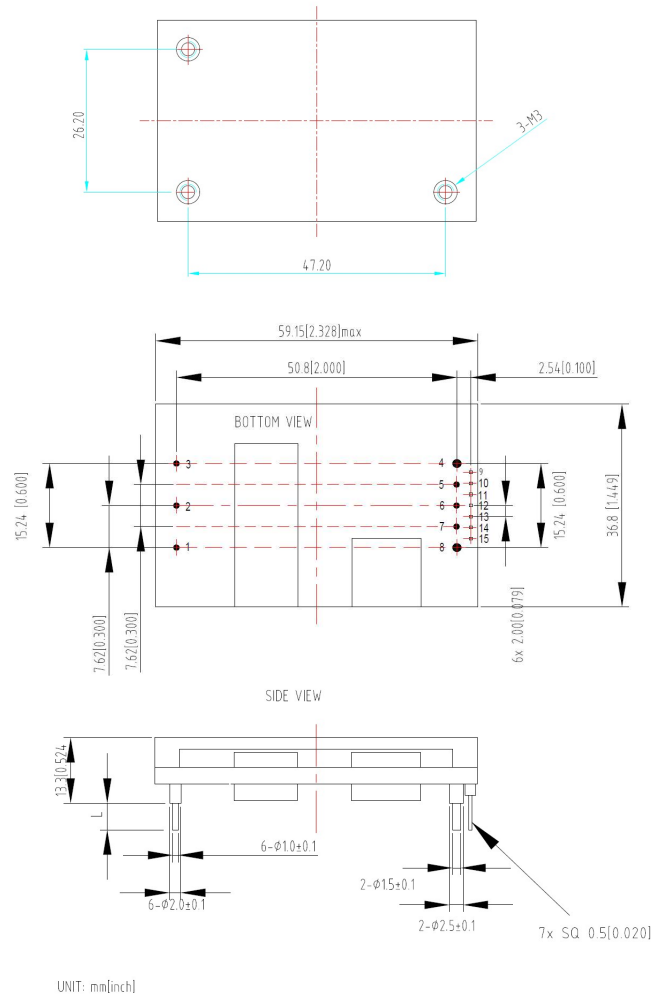

Figure 11: ADQ600B-48S12B Current Limit Characteristic



# Mechanical Specifications

## Mechanical Outlines – Baseplate Module



UNIT: mm[inch]

TOLERANCE: X.X mm±0.5 mm[X.XX in. ±0.02 in.]

X.XX mm±0.25 mm[X.XXX in. ±0.01 in.]

### Pin length option

Table 4. Pin length option	
Device code suffix	L
-4	4.8mm ± 0.25 mm
-6	3.8mm ± 0.25 mm
-8	2.8mm ± 0.25 mm
None	5.8mm ± 0.25 mm

## Mechanical Specifications

### Pin Designations

Pin No	Name	Function
1	$V_{IN+}$	Positive input voltage
2	Remote ON/OFF	Remote control
3	$V_{IN-}$	Negative input voltage
4	$V_{O-}$	Negative output voltage
5	-Sense	Remote sense negative
6	trim	Voltage adjustment
7	+Sense	Remote sense positive
8	$V_{O+}$	Positive output voltage

## Environmental Specifications

### EMC Immunity

ADQ600B-48S12B power supply is designed to meet the following EMC immunity specifications:

Table 4. Environmental Specifications:		
Document	Description	Criteria
EN55032, Class B Limits	Conducted EMI Limits	B
IEC/EN 61000-4-2, Level 3	Electromagnetic Compatibility (EMC) - Testing and measurement techniques - Electrostatic discharge immunity test. Enclosure Port	B
IEC/EN 61000-4-6, Level 2	Electromagnetic Compatibility (EMC) - Testing and measurement techniques, Continuous Conducted Interference. DC input port	A
IEC/EN 61000-4-4, Level3	Electromagnetic Compatibility (EMC) - Testing and measurement techniques, Electrical Fast Transient. DC input port.	B
IEC/EN 61000-4-5	Electromagnetic Compatibility (EMC) - Testing and measurement techniques, Immunity to surges - 600V common mode and 600V differential mode for DC ports	B
EN61000-4-29	Electromagnetic Compatibility (EMC) - Testing and measurement techniques, Voltage Dips and short interruptions and voltage variations. DC input port	B

Criterion A: Normal performance during and after test.

Criterion B: For EFT and surges, low-voltage protection or reset is not allowed. Temporary output voltage fluctuation ceases after disturbances ceases, and from which the EUT recovers its normal performance automatically. For Dips and ESD, output voltage fluctuation or reset is allowed during the test, but recovers to its normal performance automatically after the disturbance ceases.

### Recommend EMC Filter Configuration

See Figure20.

## Environmental Specifications

### Safety Certifications

The ADQ600B-48S12B power supply is intended for inclusion in other equipment and the installer must ensure that it is in compliance with all the requirements of the end application. This product is only for inclusion by professional installers within other equipment and must not be operated as a stand alone product.

**Table 6. Safety Certifications for ADQ600B-48S12B series power supply system**

Standard	Agency	Description
UL/CSA 62368	UL+CUL	US and Canada Requirements
EN62368	TUV-SUD	European Requirements
IEC62368	UL	International Requirements
CE	TUV-SUD	CE Marking
TUV	CE	Germany Requirements
UL94,V-0		flammability rating
UKCA		UK Requirements

## Environmental Specifications

### Operating Temperature

The ADQ600B-48S12B supplies will start and operate within stated specifications at an ambient temperature from  $-40\text{ }^{\circ}\text{C}$  to  $85\text{ }^{\circ}\text{C}$  under all load conditions. The storage temperature is  $-55\text{ }^{\circ}\text{C}$  to  $125\text{ }^{\circ}\text{C}$

### Thermal Considerations - Open-Frame

The converter is designed to operate in different thermal environments and sufficient cooling must be provided. Proper cooling can be verified by measuring the temperature at the test points as shown in figure 12. The temperature at this point should not exceed the max values in the table 7.

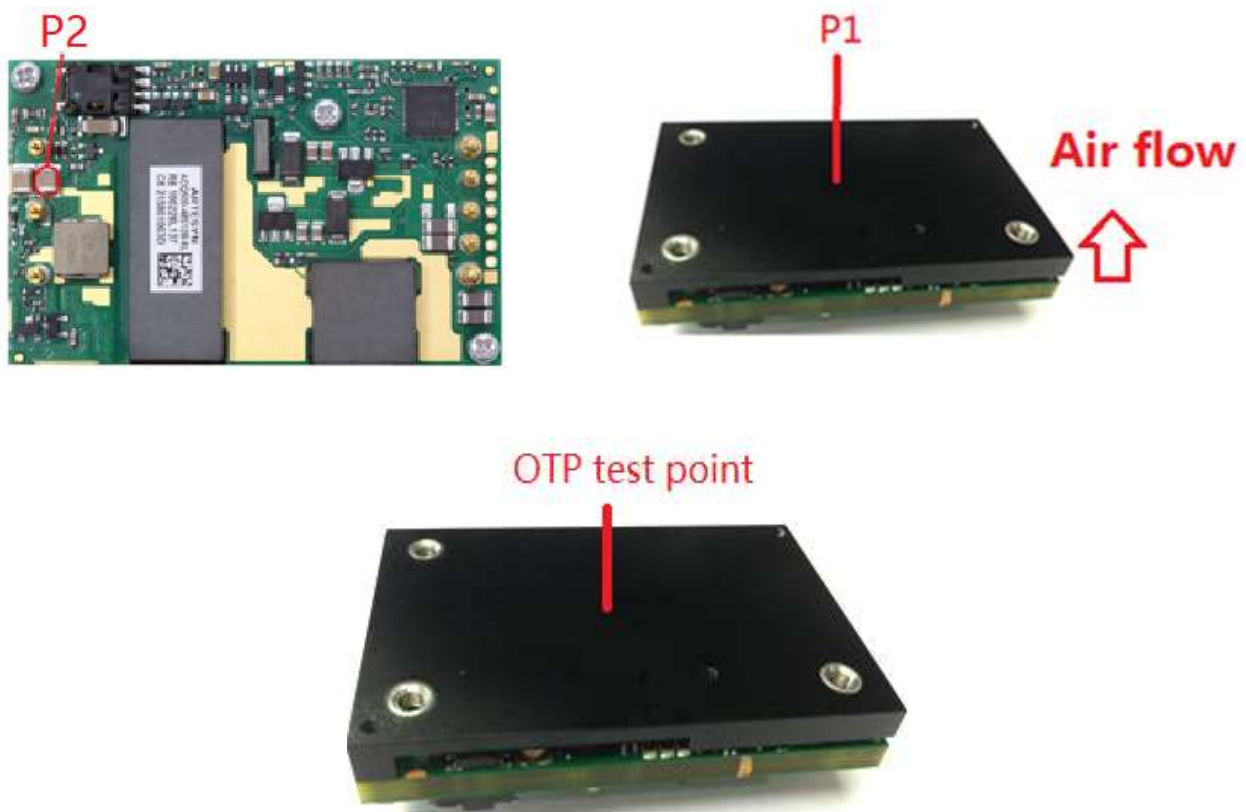
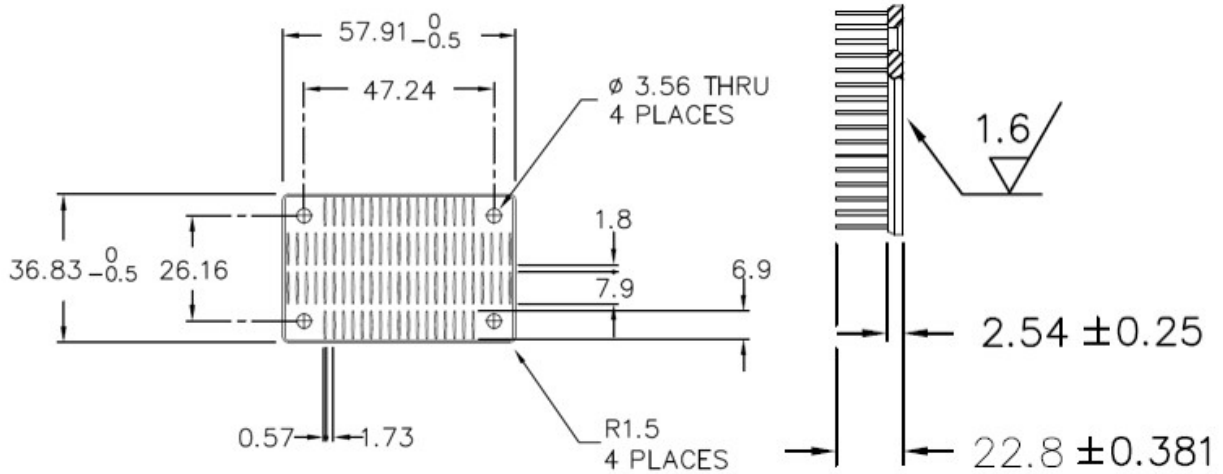
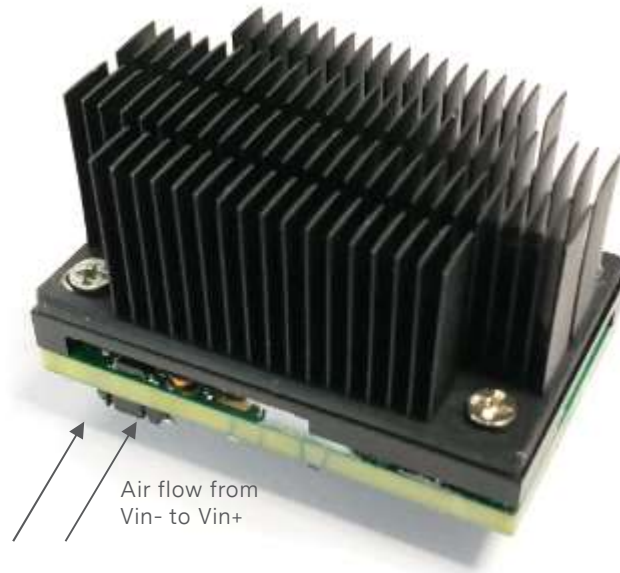

Figure 12 Thermal test points(TOP)

Table 7. Temperature limit of the test point	
Test Point	Temperature limit
P1	$100\text{ }^{\circ}\text{C}$
P2	$115\text{ }^{\circ}\text{C}$

## Environmental Specifications

The typical test condition is shown in Figure 13. For a typical application, figure 14 shows the derating of output current vs. ambient air temperature at different air velocity @48V input.



Dimensions : mm

Figure 13 Typical test condition, heatsink

## Environmental Specifications

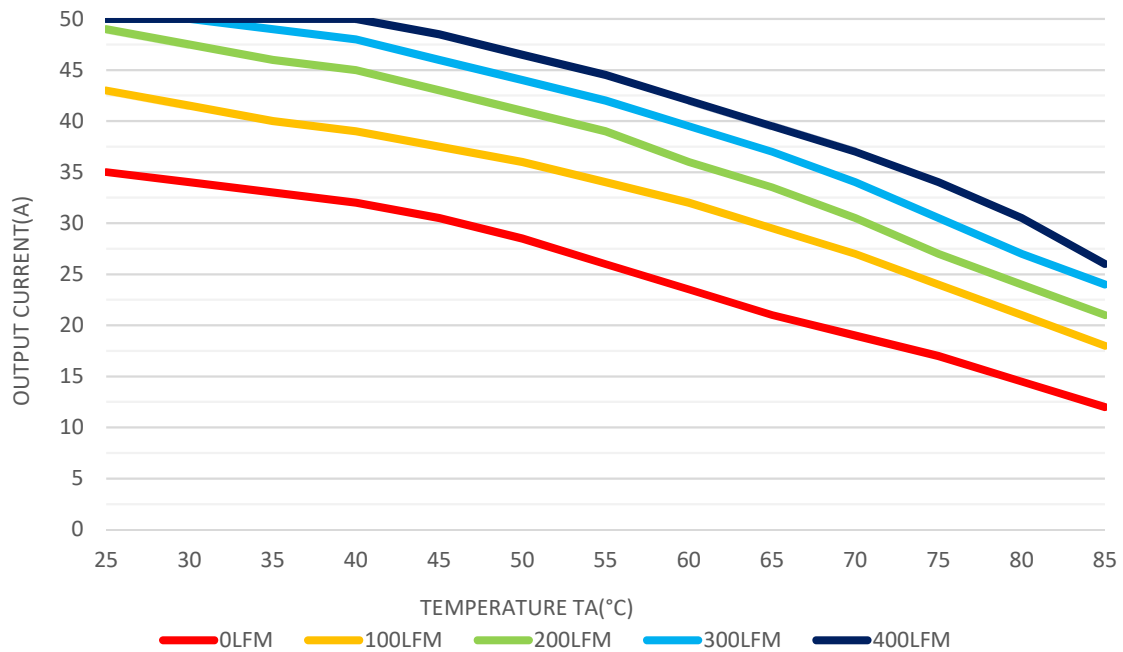

Figure 14 Output power derating, 48Vin, air flowing across the converter from  $V_{IN-}$  to  $V_{IN+}$

## Environmental Specifications

### Qualification Testing

Table 8. Qualification testing		
Parameter	Unit (pcs)	Test condition
Halt test	4-5	$T_{a,min} -10\text{ }^{\circ}\text{C}$ to $T_{a,max}+30\text{ }^{\circ}\text{C}$ , $5\text{ }^{\circ}\text{C}$ step, $V_{IN}$ = min to max, 0 ~ 100% load
Vibration	3	Frequency range: 5Hz ~ 20Hz, 20Hz ~ 200Hz, A.S.D: $1.0\text{m}^2/\text{s}^3$ , -3db/oct, axes of vibration: X/Y/Z. Time: 30min/axes
Mechanical Shock	3	30g, 6ms, 3 axes, 6 directions, 3 time/direction
Thermal Shock	3	$-55\text{ }^{\circ}\text{C}$ to $125\text{ }^{\circ}\text{C}$ , unit temperature 20 cycles
Thermal Cycling	3	$-40\text{ }^{\circ}\text{C}$ to $85\text{ }^{\circ}\text{C}$ , temperature change rate: $1^{\circ}\text{C}/\text{min}$ , cycles: 2 cycles
Humidity	3	$40\text{ }^{\circ}\text{C}$ , 95%RH, 48h
Solder Ability	15	IPC J-STD-002C-2007



## Application Notes

### Typical Application

Below is the typical application of the ADQ600B-48S12B series power supply.

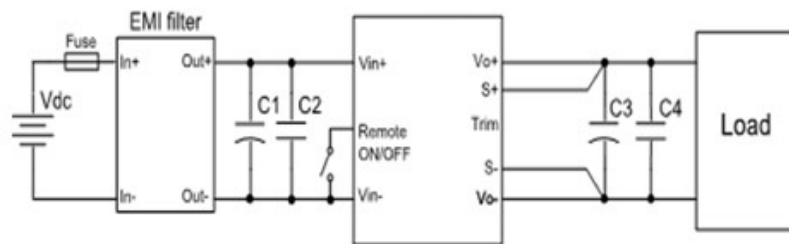

Figure 15 Typical application

C1: 220 $\mu$ F/100V electrolytic capacitor, P/N: UPM2A221MPD (Nichicon) or equivalent caps

C2: 1 $\mu$ F/100V X7R ceramic capacitor, P/N: C3225X7R2A105KT0L0U (TDK) or equivalent caps

C3: 2200 $\mu$ F Al electrolytic

C4: 22 $\mu$ F/16V X7R ceramic capacitor \*137(about 3000 $\mu$ F), P/N: C3225X7R1C226KT000N (TDK) or equivalent caps type

Fuse: External fast blow fuse with a rating of 30A/250Vac. The recommended fuse model is 0314030 MRP from Karwin Tech limited.

EMI filter: Refer to figure 20

### Remote ON/OFF

Negative remote ON/OFF logic is available in ADQ600B-48S12B. The logic is CMOS and TTL compatible. Below is the detailed internal circuit and reference in ADQ600B-48S12B.

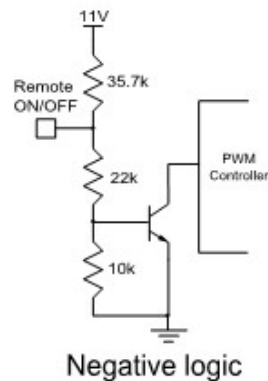

Figure 16 Remote ON/OFF internal diagram

### Remote Sense

If the load is far from the unit, connect S+ and S- to the terminal of the load respectively to compensate the voltage drop on the transmission line. See Figure 15. If the sense compensate function is not necessary, connect S+ to Vo+ and S- to Vo- directly.

## Application Notes

### Trim Characteristics

To increase or decrease the output voltage set point, connect an external resistor between the TRIM pin and either the Vo+ or Vo-. The TRIM pin should be left open if this feature is not used. Below Trim equation is only adapt to the module without droop current sharing option code; For the module with droop current sharing option code, please contact Artesyn's technical support team. Connecting an external resistor between Trim pin and Vo- pin will decrease the output voltage. While connection it between Trim and Vo+ will increase the output voltage. The following equations determine the external resistance to obtain the trimmed output voltage.

$$R_{adj-down} = \frac{511}{\Delta} - 10.22(K\Omega)$$

$$R_{adj-up} = \frac{5.11 \times V_{nom} \times (100 + \Delta)}{1.225 \times \Delta} - \frac{511}{\Delta} - 10.22(K\Omega)$$

$\Delta$ : Output e rate against nominal output voltage.

$$\Delta = \frac{100 \times (V_{nom} - V_0)}{V_{nom}}$$

$V_{norm}$ : Nominal output voltage.

For example, to get 13.2V output, the trimming resistor is

$$\Delta = \frac{100 \times (V_{nom} - V_0)}{V_{nom}} = \frac{100 \times (13.2 - 12)}{12} = 10$$

The output voltage can also be trimmed by potential applied at the Trim pin.

$$R_{adj-up} = \frac{5.11 \times 12 \times (100 + 10)}{1.225 \times 10} - \frac{511}{10} - 10.22 = 489.3(K\Omega)$$

$$V_0 = (V_{trim} + 1.225) \times 1.347$$

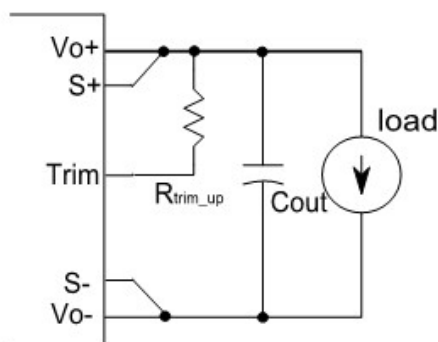

Figure 17 Trim up

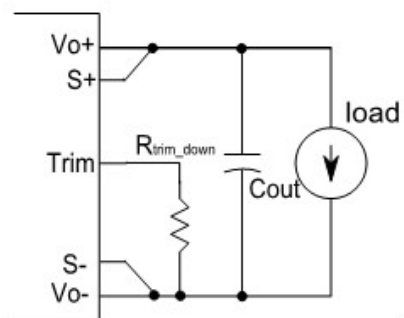

Figure 18 Trim down

Where is the potential applied at the Trim pin, and Vo is the desired output voltage. When trimming up, the output current should be decreased accordingly so as not to exceed the maximum output power.

## Application Notes

### Input Ripple & Inrush Current and Output Ripple & Noise Test Configuration

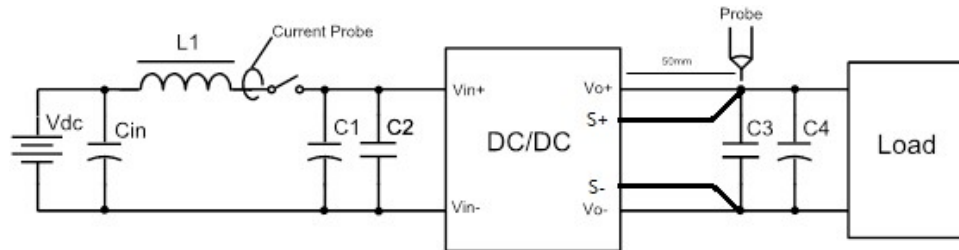

Figure 19 Input ripple & inrush current output ripple & noise test configuration

Vdc: DC power supply

L1: 12 $\mu$ H

Cin: 220 $\mu$ F/100V typical

C1 ~ C4: See Figure 15

Note: Using a coaxial cable with series 50 $\Omega$  resistor and 0.68 $\mu$ F ceramic capacitor or a ground ring of probe to test output ripple & noise is recommended.

### EMC test conditions

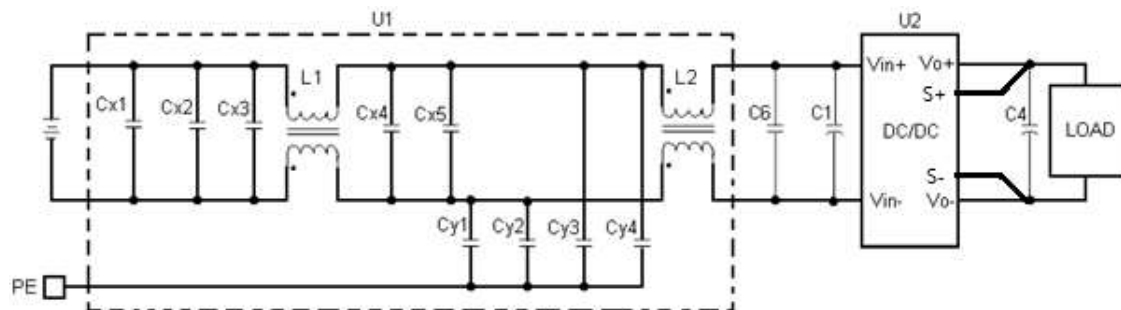

Figure 20 EMC test configuration

U1: Input EMC filter

U2: Module to test, ADQ600B-48S12B

C<sub>x1</sub>: 1000nF/100V/X7R capacitor\*2

C<sub>x2</sub>: 1000nF/100V/X7R capacitor

C<sub>x4</sub>: 1000nF/100V/X7R capacitor\*3

C<sub>x3</sub>, C<sub>x5</sub>: 2200nF/100V/X7S capacitor

C<sub>y1</sub>, C<sub>y2</sub>, C<sub>y3</sub>, C<sub>y4</sub>: 0.47 $\mu$ F/630V/X7T, Y capacitor\*2

L1, L2: 473 $\mu$ H, common mode inductor

C6: 1000nF/100V/X7R capacitor

C1: 220 $\mu$ F/100V electrolytic capacitor

C4: See Figure 15

## Application Notes

### Weight

The ADQ600B-48S12B-6LI weight is 80.3g.maximum.(65.7g.minmum)

## Application Notes

### Soldering

Wave Soldering

The product is intended for standard manual or wave soldering.

When wave soldering is used, the temperature on pins is specified to maximum 255 °C for maximum 7s.

When soldering by hand, the iron temperature should be maintained at 300 °C ~ 380 °C and applied to the converter pins for less than 10s. Longer exposure can cause internal damage to the converter.

Cleaning of solder joint can be performed with cleaning solvent IPA or simulative.

## PMBus Communication

### PMBus Communication

The module has a digital PMBus interface to allow the module to be monitored, controlled and configured by the system. The module supports 3 PMBus signal lines, Data, Clock, Control (C2 pin, optional), and 2 Address line Addr0 and Addr1. More detail PMBus information can be found in the PMBus Power Management Protocol Specification, Part I and part II, revision 1.2; which is shown in <http://pmbus.org>. 100kHz bus speeds is supported by the module.

The module supports the Packet Error Checking (PEC) protocol. It can check the PEC byte provided by the PMBus master, and include a PEC byte in all message responses to the master.

The module contains a data flash used to store configuration settings, which will not be programmed into the device data flash automatically. The STORE\_DEFAULT\_ALL command must be used to commit the current settings are transfer from RAM to data flash as device defaults.

### PMBus Addressing

The module has fixed PMBUS address (0x59). Through this address, the host computer can address the module.

## PMBus Communication

### PMBus Data Format

The module receives and report data in LINEAR format. The Exponent of the data words is fixed at a reasonable value for the command; altering the exponent is not supported. DIRECT format is not supported by the module.

For commands that set or report any voltage thresholds related to the output voltage, the module supports the linear data format consisting of a two byte value with a 16-bit, unsigned mantissa, and a fixed exponent of -9. The format of the two data bytes is shown below:

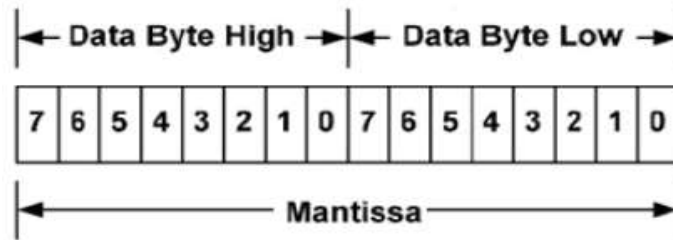

The equation can be written as:

$$V_{out} = \text{Mantissa} \times 2^{-9}$$

For example, considering set  $V_{out}$  to 12V by `VOUT_COMMAND`, the read/write data can be calculated refer to below process:

1. Mantissa =  $V_{out}/2^{-9} = 12/2^{-9} = 6144$ ;
2. Converter the calculated Mantissa to hexadecimal 0x1800.

For commands that set or report all other thresholds, including input voltages, output current, temperature, time and frequency, the supported linear data format is a two byte value with: an 11 bit, two's complement mantissa, and a 5 bit, two's complement exponent (scaling factor). The format of the two data bytes is shown as in below.

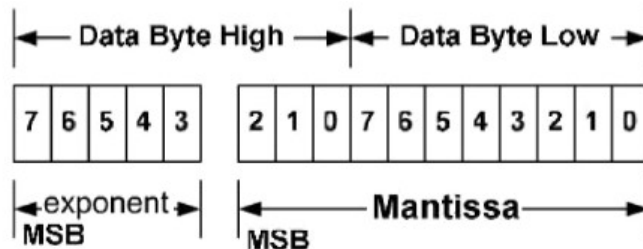

The equation can be written as:

$$\text{Value} = \text{Mantissa} \times 2^{\text{exponent}}$$

For example, considering set the turn on threshold of input under voltage lockout to 33V by `VIN_ON` command; the read/write data can be calculated refer to below process:

1. Get the exponent of  $V_{in}$ , 0; whose binary is 00000
2. Mantissa =  $V_{in}/=33/=33$ ;
3. Converter the calculated Mantissa to hexadecimal 21, then converter to binary 00000100001;
4. Combine the exponent and the mantissa, 00000 and 0000000000100001;
5. Converter binary 0000000000100001 to hexadecimal 0021.

The detail exponent and resolution of main parameter is to be decided later.

## PMBus Communication

### Supported PMBus Command

The main PMBus commands described in the PMBus 1.2 specification are supported by the module. Partial PMBus commands are fully supported; Partial PMBus commands have difference with the definition in PMBus 1.2 specification. The details about all the supported PMBus commands are to be decided later.

ADQ600B-48S12B-6LI Supported PMBus™ Command List:

Command Code	Command Name	Default Value	Access Type	Data Bytes	Data Format	Description
0x01	OPERATION	0x80	R/W	1	Bit field	Turn the module on or off by PMBUS command.
0x03	CLEAR_FAULTS	/	Send	1	/	Clear any fault bits that have been set.
0x11	STORE_DEFAULT_ALL	/	Send	1	/	Stores operating parameters from RAM to data flash. This command is effective to the parameter of all command in the table.
0x12	RESTORE_DEFAULT_ALL	/	Send	1	/	Restores operating parameters from data flash to RAM. This command can't be issued when the power unit is running.
0x20	VOUT_MODE	0x17	Read	1	mode+exponent	To read Vo data format.
0x21	VOUT_COMMAND	12.0Vdc	R/W	2	Vout Linear	Set the output voltage. Range: 9.6~13.2Vdc Exponent: -9
0x33	FREQUENCY_SWITCH	175KHz	R/W	2	Linear	Set the switching frequency. Range: 150~180KHz
0x35	VIN_ON	34Vdc	R/W	2	Linear	Set the turn on voltage threshold of Vin under voltage lockout. VIN_ON should be higher than VIN_OFF, and keep 2V hysteresis. Range: 32~46Vdc
0x36	VIN_OFF	32Vdc	R/W	2	Linear	Set the turn off voltage threshold of Vin under voltage lockout. VIN_ON should be higher than VIN_OFF, and keep 2V hysteresis. Range: 31~46Vdc
0x40	VOUT_OV_FAULT_LIMIT	15Vdc	R/W	2	Vout Linear	Set the output overvoltage fault threshold. Must be higher than the value of VOUT_COMMAND and VOUT_OV_WARN_LIMIT; Range:11-16Vdc Exponent:-9
0x41	VOUT_OV_FAULT_RESPONSE	0xB8	Read	1	Bit field	Instructs what action to take in response to an output overvoltage fault.
0x42	VOUT_OV_WARN_LIMIT	15Vdc	R/W	2	Vout Linear	Set a threshold causing an output voltage high warning. Must be less than VOUT_OV_FAULT_LIMIT value. Range:11~16Vdc Exponent:-9



## PMBus Communication

ADQ600B-48S12B-6LI Supported PMBus™ Command List:

Command Code	Command Name	Default Value	Access Type	Data Bytes	Data Format	Description
0x46	IOUT_OC_FAULT_LIMIT	50A	R/W	2	Linear	Set the output overcurrent fault threshold. Must be greater than IOUT_OC_WARN_LIMIT value Range:20~60A
0x47	IOUT_OC_FAULT_RESPONSE	0xF8	Read	1	Bit field	Instructs what action to take in response to an output overcurrent fault.
0x4A	IOUT_OC_WARN_LIMIT	46A	R/W	2	Linear	Set a threshold causing an output current high warning. Must be less than IOUT_OC_FAULT_LIMIT value. Range:10~45A
0x4F	OT_FAULT_LIMIT	120Deg.C	R/W	2	Linear	Set the over temperature fault threshold. Range:25~140 Deg.C
0x55	VIN_OV_FAULT_LIMIT	110Vdc	R/W	2	Linear	Set the input overvoltage fault threshold. Range:48~110Vdc
0x5E	POWER_GOOD_ON	11Vdc	R/W	2	Vout Linear	Sets the output voltage at which the bit 3 of STATUS_WORD high byte should be asserted. Must be greater than POWER_GOOD_OFF value by 1.6V. Range:8.1 ~13.2Vdc Exponent:-9
0x5F	POWER_GOOD_OFF	9Vdc	R/W	2	Vout Linear	Sets the output voltage at which the bit 3 of STATUS_WORD high byte should be negated. Must be less than POWER_GOOD_ON value by 1.6V. Range:8.1 ~13.2Vdc Exponent:-9
0x79	STATUS_WORD	/	Read	2	Bit field	Returns the information with a summary of the module's fault/warning.
0x88	READ_VIN	/	Read	2	Linear	Returns the input voltage of the module.
0x8B	READ_VOUT	/	Read	2	Vout Linear	Returns the output voltage of the module.
0x8C	READ_IOUT	/	Read	2	Linear	Returns the output current of the module.
0x8E	READ_TEMPERATURE_1	/	Read	2	Linear	Returns the module's hot spot temperature of the module.
0x98	PMBUS_REVISION	1.2	Read	1	Bit field	Reads the revision of the PMBus.
0xE0	MFR_C2_Configure	0x00	R/W	1	Bit field	Configures the C2 pin (secondary on/off pin) function and logic;
0xE1	MFR_PGOOD_POLARITY	0x00	R/W	1	Bit field	Configure Power Good logic.
0xF7	MFR_C1_C2_ARA_CONFIG	0x00	R/W	1	Bit field	Configure C2 pin function.

## PMBus Communication

### OPERATION [0x01]

Bit number	Purpose	Bit Value	Meaning	Default Settings: 0x80
7:	Enable/Disable the module	1	Output is enabled	1
		0	Output is disabled	
6:	Reserved			0
5:4	Margins	00	No margin	00
		01	Margin low(Act on Fault)	
		10	Margin high(Act on Fault)	
3:0	Reserved			0000

### VOUT\_OV\_FAULT\_RESPONSE [0x41]

Bit number	Purpose	Bit Value	Meaning	Default Settings:0xB8
7: 6	Response settings	10	Unit shuts down and responds according to the retry settings	10
5:3	Retry setting	111	Unit continuously restarts while fault is present until commanded off	111
		000	Unit does not attempt to restart on fault	
2:0	Delay time setting	000	No delay supported	000

### IOUT\_OC\_FAULT\_RESPONSE [0x47]

Bit number	Purpose	Bit Value	Meaning	Default Setting:0xF8
7: 6	Response settings	11	Unit shuts down and responds according to the retry settings	11
5:3	Retry setting	111	Unit continuously restarts while fault is present until commanded off	111
		000	Unit does not attempt to restart on fault	
2:0	Delay time setting	000	No delay supported	000

## PMBus Communication

STATUS\_WORD [0x79]

High byte

Bit number	Purpose	Bit Value	Meaning
7	An output over voltage fault or warning	1	Occurred
		0	No Occurred
6	An output over current fault or warning	1	Occurred
		0	No Occurred
5	An input voltage fault, including over voltage and under-voltage	1	Occurred
		0	No Occurred
4	Reserved		
3	Power_Good	1	is negated
		0	ok
2:0	Reserved		

## PMBus Communication

Low Byte

Bit number	Purpose	Bit Value	Meaning
7	Reserved		
6	OFF (The unit is not providing power to the output by OCP OVP OVIN)	1	Occurred
		0	No Occurred
5	An output over voltage fault	1	Occurred
		0	No Occurred
4	An output over current fault	1	Occurred
		0	No Occurred
3	An input under voltage fault	1	Occurred
		0	No Occurred
2	A temperature fault or warning	1	Occurred
		0	No Occurred
1	Reserved		
0	Reserved		

MFR\_C1\_C2\_ARA\_CONFIG [0xF7]

Bit number	Purpose	Bit Value	Meaning
7:5	Reserved	000	Reserved
4	Reserved	0	Reserved
3:0	PIN Configuration	0000	C2 pin: POWER_GOOD
		0010	C2 pin: ON/OFF (Secondary)

## PMBus Communication

MFR\_C2\_Configure [0xE0]

Bit number	Purpose	Bit Value	Meaning
7:2	Reserved	000000	Reserved
1	ON/OFF Configuration	0	Secondary side on/off pin state when mapped to C2 is ignored
		1	AND – Primary and Secondary side on/off
0	PIN Configuration	0	Negative Logic (Low Enable: Input < 0.8V wrt Vout(-))
		1	Positive Logic (High Enable: Input > 2.0V wrt Vout(-))

MFR\_PGOOD\_POLARITY [0xE1]

Bit number	Purpose	Bit Value	Meaning
7:1	Reserved	0000000	Reserved
0	Power Good Logic	0	Negative PGOOD logic
		1	Positive PGOOD logic

## Record of Revision and Changes

Issue	Date	Description	Originators
1.0	02.02.2021	First Issue	J. Zhang
1.1	05.20.2022	Add UKCA Mark	J. Zhang



For international contact information,  
visit [advancedenergy.com](http://advancedenergy.com).

[powersale@aei.com](mailto:powersale@aei.com) (Sales Support)  
[productsupport.ep@aei.com](mailto:productsupport.ep@aei.com) (Technical Support)  
+1 888 412 7832

## ABOUT ADVANCED ENERGY

Advanced Energy (AE) has devoted more than three decades to perfecting power for its global customers. AE designs and manufactures highly engineered, precision power conversion, measurement and control solutions for mission-critical applications and processes.

Our products enable customer innovation in complex applications for a wide range of industries including semiconductor equipment, industrial, manufacturing, telecommunications, data center computing, and medical. With deep applications know-how and responsive service and support across the globe, we build collaborative partnerships to meet rapid technological developments, propel growth for our customers, and innovate the future of power.

## PRECISION | POWER | PERFORMANCE

---

Specifications are subject to change without notice. Not responsible for errors or omissions. ©2020 Advanced Energy Industries, Inc. All rights reserved. Advanced Energy®, and AE® are U.S. trademarks of Advanced Energy Industries, Inc.